

centrifugal gravity separator

Introduction

Auxill Centrifugal Gravity Separators are solids removal devices which rely on centrifugal force and the specific gravity of solids for efficient operation. The particle size and the difference in specific weight between liquid and the solids prescribe the efficiency of the separator. The tangential inlet and the special spinflex construction in the top dome of the separator guarantee the optimal centrifugal action, required to achieve efficient and continuous separation. Circulation or a setup in series of two separators will increase the effectiveness with 30 to 45 percent.



Applications

- Source water intake
- Washing operations
- Fire-fighting systems
- Coolant filtration
- De-sanding
- Pump protection
- Pre-filtration
- Waste water upgrading.

Benefits

- Low pressure-drop
- No moving parts
- Continuous filtering
- No filter-media
- Ecologically sound
- Easy installation
- Low maintenance costs
- High efficiency
- Closed system
- Automatic purging possible.

Operation

Operation in general

Liquid enters the unit tangential, which creates a centrifugal flow. A special top inlet construction accelerates the centrifugal flow. Centrifugal force moves the heavy particles against the inside of the separator housing. These solids slowly drop along the side to the collection chamber. Cleaned liquid is drawn up through the vortex and leaves the separator by the top outlet. Solids are either periodically or continuously purged from the collection chamber.

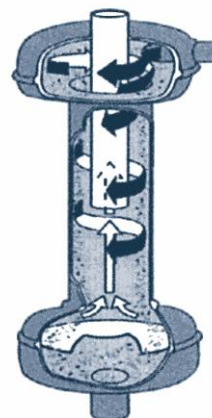

Technical operation

Auxill Separators are designed to operate within a range of 1 to 10 bar pressure across the unit. A manual throttling valve in the discharge piping will allow adjustment of the pressure drop, and therefore the flow rate, across the unit. Operation outside of the specified range may result in reduced efficiency and possible damage to the unit. Upon initial start-up, the amount of purged solids generated by the separator will likely be high. Initially, we recommend that the unit be purged hourly, until it is apparent that purge frequency can be reduced. Generally, the purge frequency can eventually be reduced to once per day. However, if daily purging results in a heavy concentration of solids, reduce the interval between purges until a maximum of 5 seconds is required to eliminate solids from the purge cycle.

It is important, however, to purge until clean liquid is observed in the purge line. This will maximize the life of the purge valve, as well as minimize leakage resulting from particles lodging in the purge valve.

Installation

Installation of the Auxill Centrifugal Gravity Separator is very simple. The separators can be placed both in-line and side-line. The large separators are in 25° inclined position, to limit required installation height.

Prior to installation

Determine the location of the separator in the piping system. Auxill Separators are typically installed on the discharge side of the pumping system. Provisions for mounting the unit are not included in the base prices of the separators. Mounting brackets are available as option extra. Determine whether the assembly facilities are such that it is strong enough to carry the weight of the separator when it is filled with liquid. Refer to the appropriate Specification Sheet for your separator to determine the operating weight of the unit. If the separator will be exposed to sub-freezing conditions, it will be necessary to provide adequate protection (isolation or shutt off) for the separator and its components to prevent freezing.

Installation separator

Determine the position of the separator. The inlet connection of the separator is located on the side of the unit, the outlet connection is at the top and the purge connection is at the bottom of the unit. Flow to the separator must enter at the inlet connection and exit at the outlet connection. The separator will not work in reverse. For proper purge operation, the separator should be installed with the purge connection located at the lowest point of the separator. For most models, this results in a vertical installation. Inspect the inlet, outlet and purge opening for any foreign matter which may have entered the unit during shipping or storage.

When piping to and from the separator, insure that appropriate hardware is used to match the inlet and outlet sizes of the separator. Auxill recommends a straight run of at least five pipe diameters upstream of the inlet connection and downstream from the outlet connection, to minimize turbulence. Flange bolts and gaskets are not included with the unit. Pressure gauges are recommended at both inlet and outlet connections to monitor pressure drop and system flow. It is necessary to install a manual throttling valve in the piping downstream of the outlet connection to allow adjustment of the pressure drop across the separator (see 'Operation').

Install a manual blow down valve on the purge connection at the bottom of the separator. Refer to the instructions included with the Automatic Purge Controller for installing the purge valve and Automatic Purge Controller, if they are part of the equipment package.

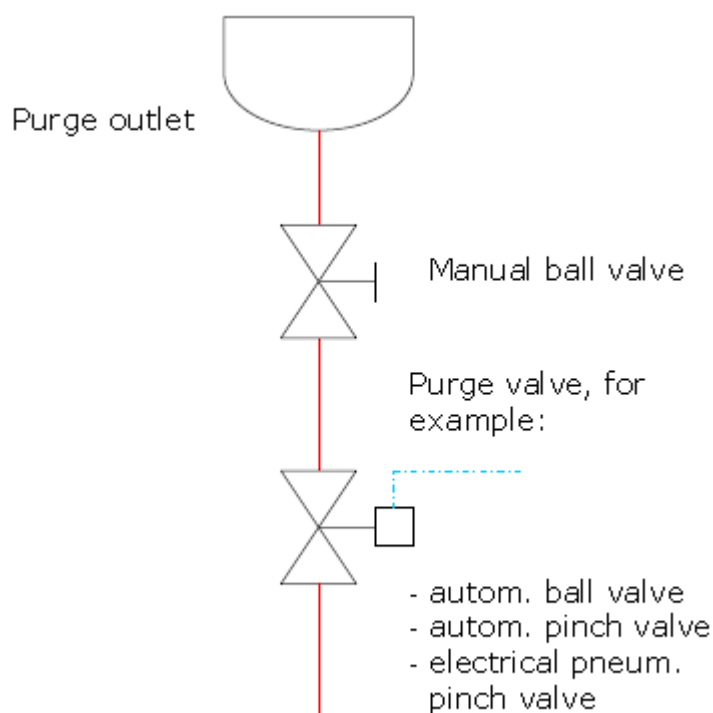

Solid sizes	
species	(μ)
human hair	30 - 200
sand	25 - 2.000
salt	2 - 20
gravel	2.000 - 65.000
pollen	10 - 150
cotton pill	40 - 300
mussel seed	20 - 120
fungus	1 - 30
zebra mussel	120 - 10.000
algae	3 - 7.000
soil scrap	10 - 500
ashes	1 - 400
flour	1 - 400
bacterium	0,5 - 25
yeast cells	2 - 30

Specific gravity	
material	(kg/dm^3)
aluminium	2,7
brass	9,0
bronze, copper	8,9
carbon, concrete	1,8 - 2,5
coal	1,3 - 1,9
ground	1,2 - 2,0
grinding particals	3,2
glass	3,0
granite, grafite	2,3
gravel	2,4
iron	7,8
lead	11,3
lime stone	2,8
magnesium	7,4
nickel	8,9



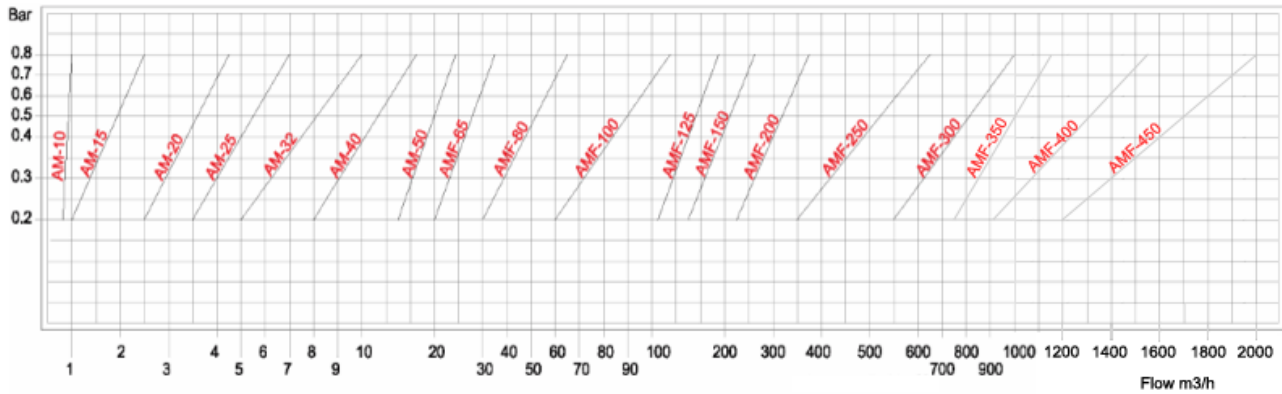

Efficiency of separation						
sg (kg/dm^3)	> 70 μ		70 - 40 μ		< 40 μ	
	single	circulation	single	circulation	single	circulation
7.8	98	98	90	94	65	84
4.2	93	98	75	92	51	72
2.4	92	97	70	91	38	65
1.9	75	93	27	55	8	31

Required information for separator selection	
Flow	Kind of liquid and application
Liquid composition	pH value
Size and nature of the solids	Density of the solids
Operational pressure	Tolerable pressure differences
Required filter fineness	Operational temperature
Available power	Pre-cleaning filter

Pressure loss of separators

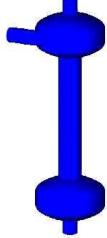

Overview of separators

				
type	AM	AMF-IO	AMF-IO	AMF-IO-RD
capacity	1 - 24 m ³ /h	20 - 60 m ³ /h	60 - 3000 m ³ /h	60 - 3000 m ³ /h
in/outlet	BSP-thread, 3/8" - 2"	DIN-flange, 4" - 20 "	DIN-flange, 4" - 20 "	DIN-flange, 4" - 20 "
material	carbonsteel, outside equipped with epoxycoating	carbonsteel, outside equipped with epoxycoating	carbonsteel, outside equipped with epoxycoating	carbonsteel, outside equipped with epoxycoating
standard	90° position	90° position 1 inspection opening	25° inclined position 1 inspection opening	25° inclined position 1 inspection opening removable dome
optional	SS 316 L flanges removable dome integrated supports special coatings long-lasting coating ANSI-flange	SS 316 L 2° inspection opening purge-outlet with flange removable dome integrated supports special coatings long-lasting coating ANSI-flange	SS 316 L 2° inspection opening purge-outlet with flange 90° position special coatings long-lasting coating ANSI-flange	SS 316 L 2° inspection opening purge-outlet with flange 90° position special coatings long-lasting coating ANSI-flange

type	connection	capacity	in/outlet	purge
301-CS-AM-10	BSP-thread	0,6 – 1,0	3/8"	3/8"
301-CS-AM-15	BSP-thread	1,0 – 2,5	1/2"	1/2"
301-CS-AM-20	BSP-thread	2,5 – 4,5	3/4"	3/4"
301-CS-AM-25	BSP-thread	3,5 – 7,0	1"	1"
301-CS-AM-32	BSP-thread	5 - 10	1 1/4"	1"
301-CS-AM-40	BSP-thread	8 - 18	1 1/2"	1"
301-CS-AM-50	BSP-thread	15 - 24	2"	1"
301-CS-AMF-IO-65	flange	20 - 35	2 1/2"	1"
301-CS-AMF-IO-80	flange	30 - 60	3"	1"
301-CS-AMF-IO-100	flange	60 - 125	4"	1"
301-CS-AMF-IO-125	flange	110 - 190	5"	1"
301-CS-AMF-IO-150	flange	155 - 260	6"	1"
301-CS-AMF-IO-200	flange	225 - 375	8"	2"
301-CS-AMF-IO-250	flange	350 - 650	10"	2"
301-CS-AMF-IO-300	flange	550 - 1000	12"	2"
301-CS-AMF-IO-350	flange	750 - 1150	14"	2"
301-CS-AMF-IO-400	flange	910 - 1550	16"	3"
301-CS-AMF-IO-450	flange	1200 - 2000	18"	3"

Estimated liquid loss at purging		
Pressure purge nozzle	1"	2"
	Ltr/sec/loss	Ltr/sec/loss
0.7	3.3	9.4
1.4	4.8	13.6
2.1	5.8	16.6
2.8	6.6	18.9
3.5	7.2	20.8
4.2	8.3	23.4
5.6	9.4	27.2
7.0	10.6	30.3
8.7	11.8	34.1
10.5	13.0	37.1
14.0	14.9	42.8
17.5	16.8	47.8

Weights		
Type	Weight	
	Netto	Operational
AM 10	6	11
AM 15	7	12
AM 20	8	13
AM 25	9	14
AM 32	14	26
AM 40	15	27
AM 50	19	33
AMF 65	24	40
AMF 80	35	65
AMF 100	47	87
AMF 125	65	123
AMF 150	160	295
AMF 200	295	515
AMF 250	410	955
AMF 300	640	1900
AMF 350	700	2200
AMF 400	750	2500
AMF 450	800	3000

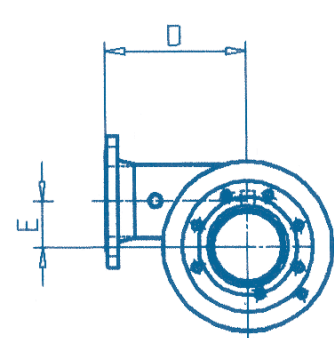
Material		Vertical position					Horizontal position							
Carbon Steel	SS 316L	A	B	C	D	E								
301-CS-AM-10	301-SS-AM-10	419	114	76	86	42								
301-CS-AM-15	301-SS-AM-15	508	168	102	102	67,5								
301-CS-AM-20	301-SS-AM-20	600	168	112	130	70								
301-CS-AM-25	301-SS-AM-25	690	168	112	130	67.5								
301-CS-AM-32	301-SS-AM-32	760	219	125	165	88								
301-CS-AM-40	301-SS-AM-40	760	219	130	170	85								
301-CS-AM-50	301-SS-AM-50	860	219	135	175	85								
301-CS-AMF-65	301-SS-AMF-65	880	219	155	195	77.5								
301-CS-AMF-80	301-SS-AMF-80	1040	244.5	168	215	70								
301-CS-AMF-100	301-SS-AMF-100	1110	300	200	260	100								
							A	B	C	D	E	F	G	H
301-CS-AMF-125	301-SS-AMF-125	1270	300	225	270	87	1213	300	350	270	87	790	225	1288
301-CS-AMF-150	301-SS-AMF-150	1640	450	225	345	150	1563	450	384	345	150	1072	226	1508
301-CS-AMF-200	301-SS-AMF-200	2220	508	355	435	175	2142	508	586	435	145	1446	400	1799
301-CS-AMF-250	301-SS-AMF-250	2930	650	470	545	200	2693	650	715	545	145	1796	411	2050
301-CS-AMF-300	301-SS-AMF-300	4470	780	660	610	240	4180	780	810	610	145	2828	600	2700
301-CS-AMF-350	301-SS-AMF-350						4200	780	870			2800	650	2700
301-CS-AMF-400	301-SS-AMF-400						4475	800	930			2850	710	2800
301-CS-AMF-450	301-SS-AMF-450						4530	800	950			2850	720	2800

Options:

For the below reproduced extra options you can give up by order the mentioned code.

- Inspection opening bottom chamber: IO
- Inspection opening both chambers: 2IO
- removable dome: RD
- Inlet other side: CC (counter clockwise)
- Special purge outlet without collection chamber: FFO
- Special rubber lining again abrasivity: RL

Example:
separator in SS 316 L, vertical position, equipped with removable dome:

301-SS-AM-32-RD
Extra options:

Manual ball-valve
Manual hose-valve
Automatic ball-valve
Pinch-valve with pneumatic actuator

Remaining:

Capacities of 3000m³ on request.

Changes under reservation:

Through continual development of our products sizes can sometimes change.
Definitive measures are available after Purchase Order.

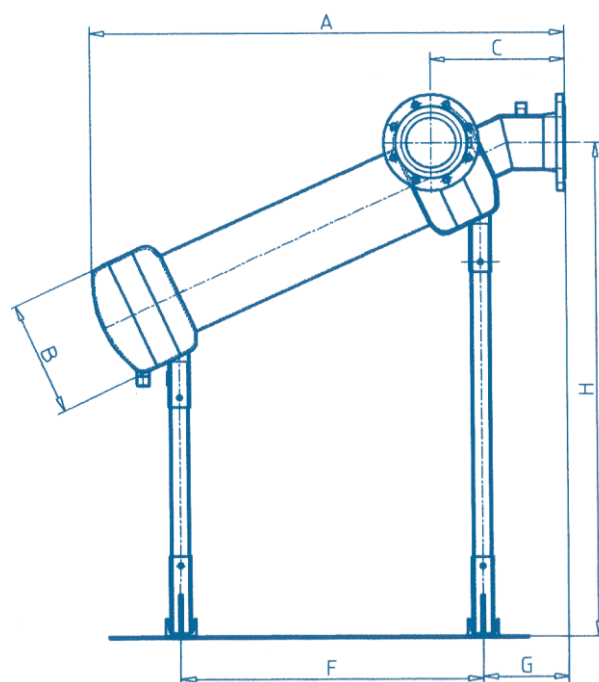
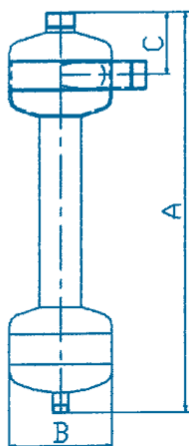
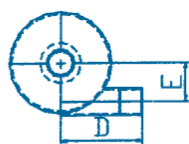

Purge Control System

Auxill Nederland offers a service to order a Purge Control System, in a simple and fast way. Below you find a number of options which apply various products of Auxill Nederland. You can order this system separately as well as per set.



Description of products

1 polyester control cabinet size hwxwd = 200x220x120 mm, equipped with a door including hinges.

A basic cabinet consist of:

- 1 polyester cabinet PD 200
- 1 mounting plate from PD 200
- 1 installation Automatic 1p + N 6A (be used as a main switch)
- 1 earth terminal USLKG5N
- 1 transformator 230 V - 24 VAC 50 Watt
- 1 glass fuse for Security transformator
- 1 schedule label on the inside of the cabinet
- 1 type label on the outside of the cabinet
- equipped with glands, weiring ducts, DIN rail and wiring
- complete mounted.

A timer consists of:

- 1 Puls Interval Timer with a separate pulse/interval time-setting voltage 24 VAC
- Time-setting 50 mSec up to 10 days for the both the pulse as the interval adjustments
- including mounting in the basic cabinet.

A pressure sensor consists of:

- 1 pressure sensor fabr. Endress & Hauser type: PTC31 with solidstate output
- the hysteresis of the output to set a minimum pressure may be turned in a maximum pressure on
- implementation with M12-connector
- 10 meter PUR cable with M12-connector cast
- 1 interface relais PLC-RSC 24VDC for output
- 1 stabilized mini implementation 230 VAC/24 VDC - 1 Amp. for power pressure sensor
- 4 rail terminals UK5-N
- including mounting in the basic cabinet.

A valve consists of:

- 1 pneumatic 3/2 valve, coil voltage 24 VAC, type SCE 374A017 MS.

Description	Productcode
Basic cabinet with timer	305-PCS-KT
Basic cabinet with timer & pressure sensor	305-PCS-KTD
Basic cabinet with timer & pressure sensor & electro pneumatic valve	305-PCS-KTDV
Basic cabinet with pressure sensor	305-PCS-KD
Basic cabinet with pressure sensor & pneumatic valve	305-PCS-KDV
Basic cabinet with pneumatic valve	305-PCS-KV
Basic cabinet with timer & pneumatic valve	305-PCS-KTV